



Synchronous Boosters for Single Frequency Networking and MaxxCasting

August 2015

Featuring
GatesAir's



Tim Anderson
Radio Product & Business
Development Manager

Synchronous Boosters for Single Frequency Networking and MaxxCasting

Timothy B. Anderson, CPBE, DRB, CBNE
Radio Product Development Manager

Most are familiar with on-frequency repeaters (boosters)

- Many recall stories of unsatisfactory performance
- Some created more problems than they solved
 - Distorted audio (multipath)
 - Weak coverage
 - Interference to primary transmitter's signal
- Some were problematic and were turned off



Traditional “Single Booster” Design

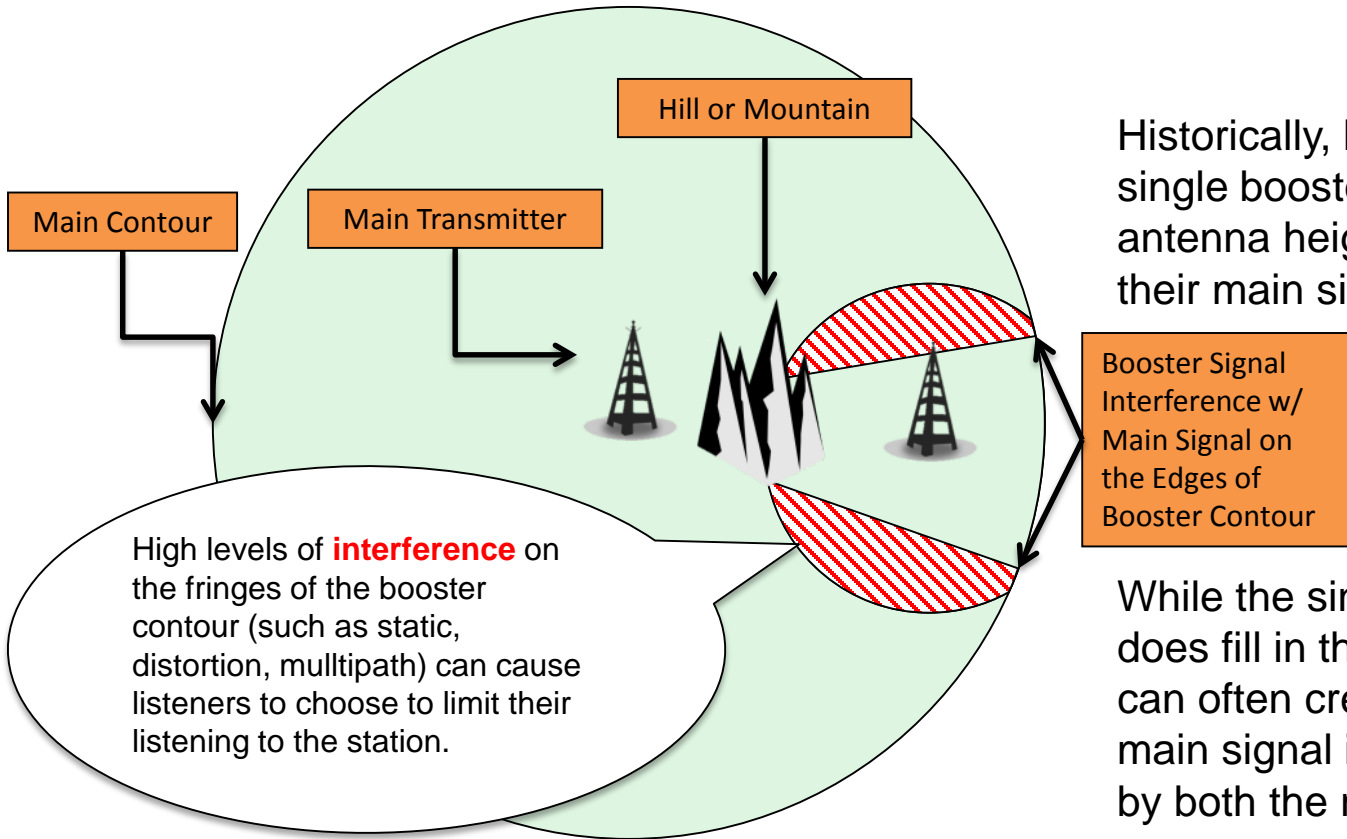

Historically, broadcasters have used single booster sites with relatively high antenna heights to fill in areas where their main signal is blocked by terrain.

Booster Signal Interference w/ Main Signal on the Edges of Booster Contour

While the single site, tall tower booster does fill in the terrain blocked area, it can often create interference with the main signal in areas that are covered by both the main and booster signals.



What is MaxxCasting™?



- Geo-Broadcast Solutions (“GBS”) has developed the MaxxCasting System that combines radio and cellular technology to enable FM Broadcasters using boosters to enhance their signals by reducing multipath interference between the main and booster transmissions through the use of a cluster of low to the ground, high power, highly directionalized synchronized booster sites.
- GBS is working in partnership with GatesAir to provide the MaxxCasting design and related equipment for broadcasters to improve existing booster problems.
- The use of multiple boosters to broadcast the same content as the main is permitted by the FCC.
- GBS has filed for a patent on the MaxxCasting System.



MaxxCasting is an FM SFN repeater system, but that is where similarity ends...

- Brings some new technologies to SFN repeater networks to resolve performance issues
 - Research into parameters that determine simulcast interference
 - Advanced geographic tools to intelligently design repeater networks
 - Calculates coverage, population, signal levels and shows interference areas, deducts total population factoring interference areas
 - Includes buildings as well as terrain



The MaxxCasting System

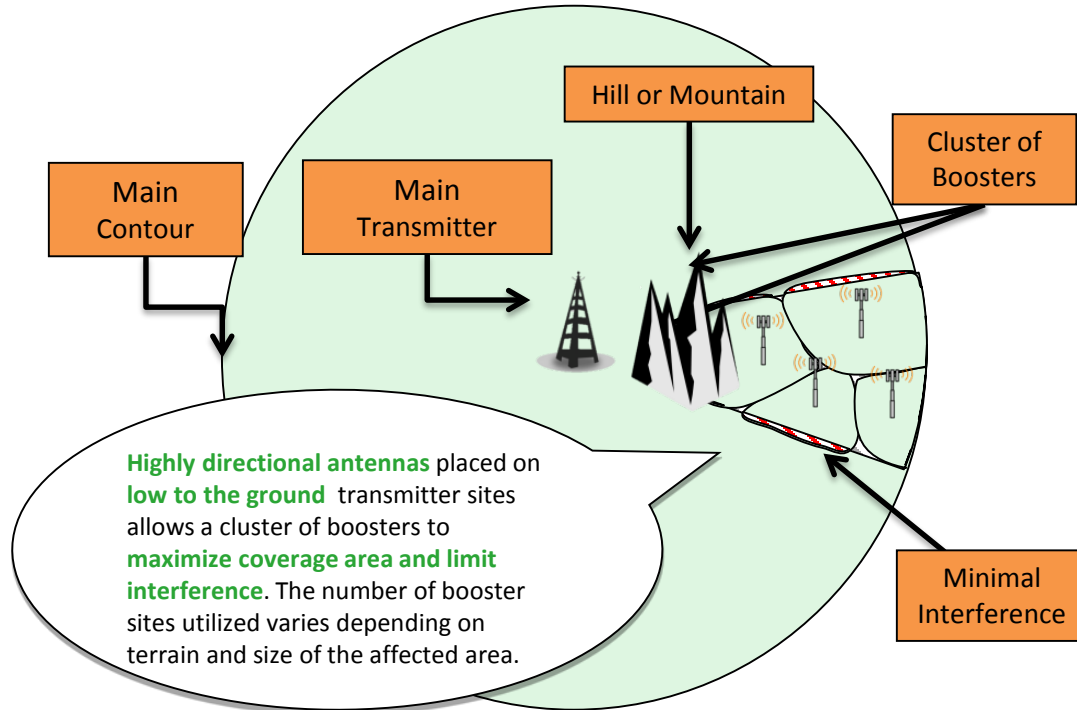

- Multiple lower-power, synchronized transmitters with lower-height, highly directional antennas, placed strategically for desired zone
- Spaced optimally to provide coverage fill-in (major roadways, building penetration)
- Proprietary Formulae Developed
 - Power ratios
 - Timing differential
 - Highly directional antenna patterns



Highly Directional Antennas

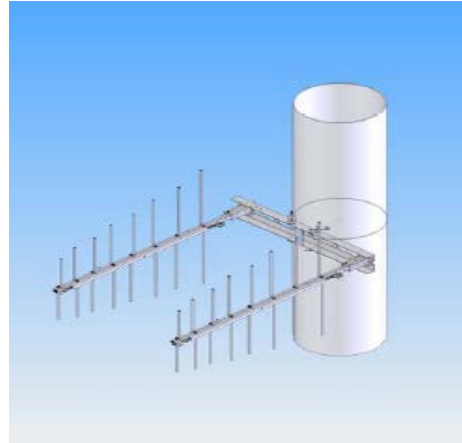
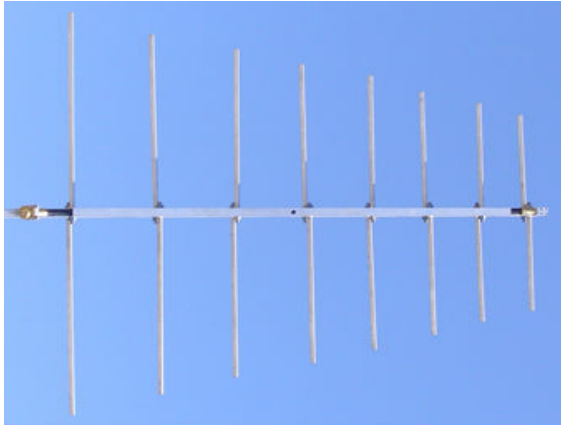

FM
Element Gain 7.5 dB
Input power 5 kW
VSWR $\leq 1.3:1$
Polarization Vertical, Horizontal or Slant
Input Connector 7/8" EIA

Azimuth Pattern, Linear Scale

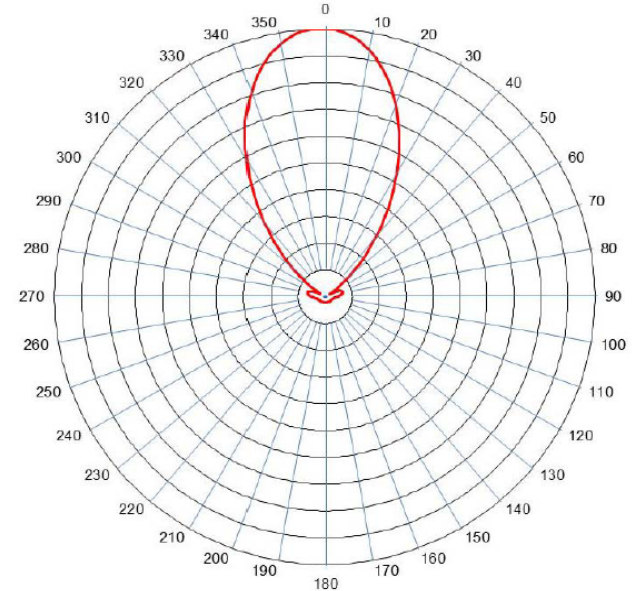

Typical MaxxCasting System

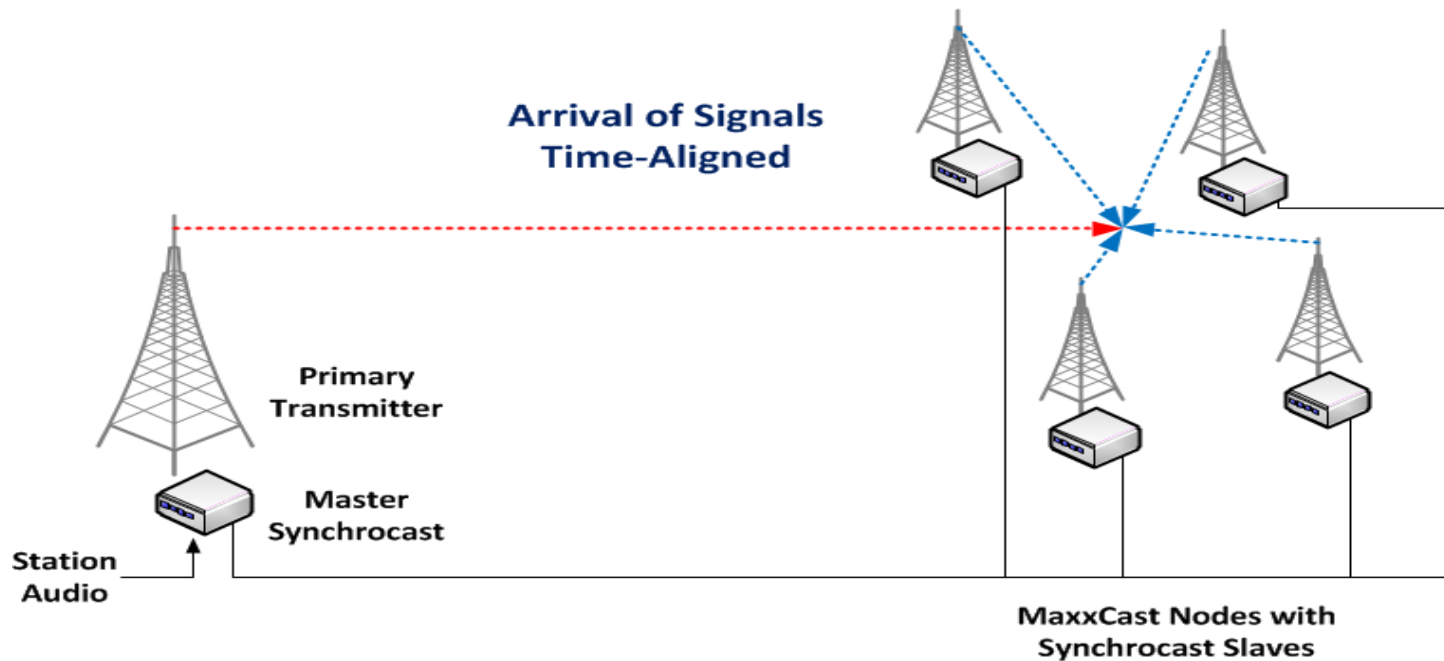

Effects of RF Simulcasting

- Broadcasting from two or more transmitters on the same frequency can lead to reception problems in the overlap areas – the areas in which the RF signal level from multiple transmitters is within $\sim 3\text{dB}$
- Precise synchronization of the RF carrier frequency and stereo pilot phase is required to prevent RF signal interference in the overlap region

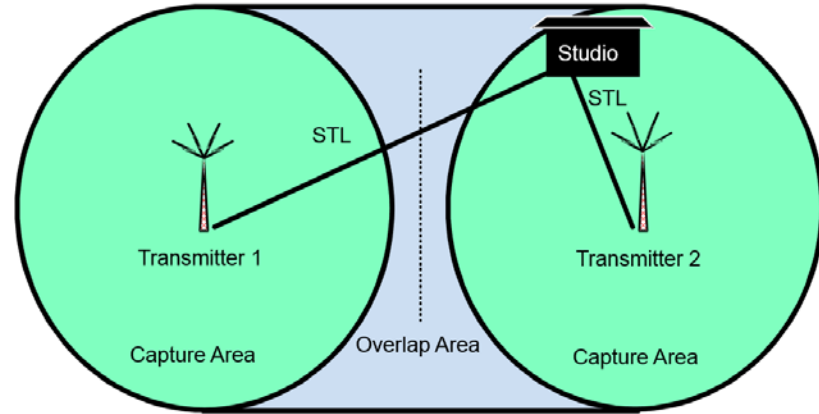
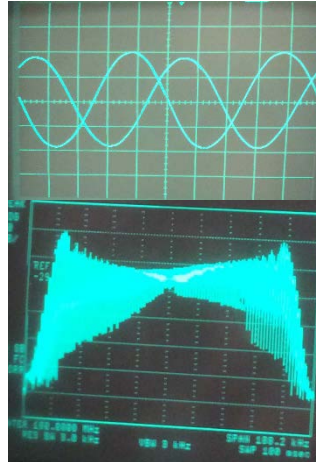
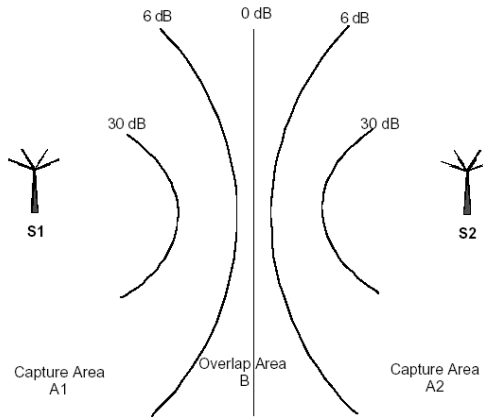

Requirements to Achieve Signal Alignment



- FM Carrier frequency, Stereo Pilot Phase and from different transmitters and Audio signal delay needs to be precisely aligned in the overlap region.
- Keep radiation going in line with main signal, don't cross it or point towards it
- Keep identical equipment in the chain at all sites (i.e. exciters; use common processor)
- Frequency and modulation synchronized with each other & primary transmitter using GatesAir IP-200 with Synchrocast®
- Distribution to sites must be stable (i.e. not the Public Internet); can be T1 or IP and compression may be used to limit bandwidth



Requirements to Achieve Signal Alignment



- Delay of the signal leaving the studio to the receiver in the overlap region must be precisely aligned between sites
- The signal leaving the studio experiences both uncontrolled STL network delay as well as several constant delays
- Constant delays includes processing within the various elements in the signal chain and the RF “flight” time in the air
- RF “flight” time is calculated based on speed of light ~300,000 km/hr
- The Exciters must produce constant processing delay and have the ability to lock the carrier and pilot with a GPS reference
- GatesAir’s Flexiva and Flexstar line of Exciters satisfy this requirement
- System Engineering activity to perform path study and delay measurements



SynchroCast Target Delay Adjustment - Example

- Audio signal delay also needs to be precisely aligned in the overlap region
- Adjust Target Delay to move the signal delay to the overlap area
- Delay difference of $3.3525 \mu\text{s}$ moves the equal delay point 1 km

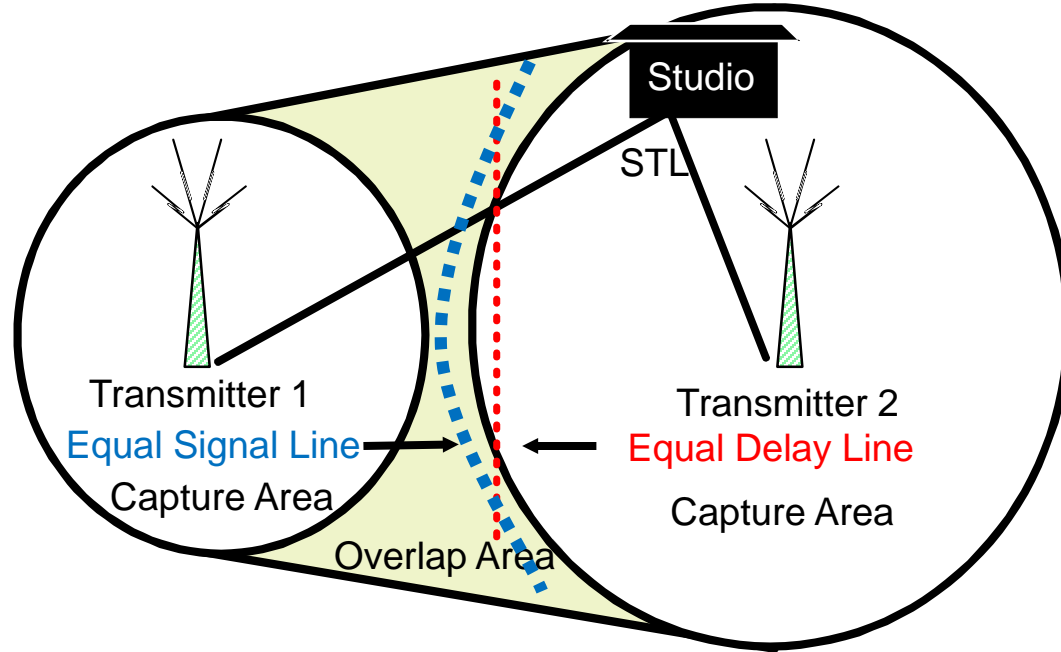

What is the role of SynchroCast?

- To keep audio alignment, GatesAir's SynchroCast system will keep a constant, precise, and user settable STL delay of the signal from studio ingest to output at each transmitter site
- Managing the delay across an IP STL is the most challenging aspect of signal alignment
- Use of GPS timing reference is key element for precision delay
- SynchroCast works with Analog, Digital and Digital MPX - AES 192

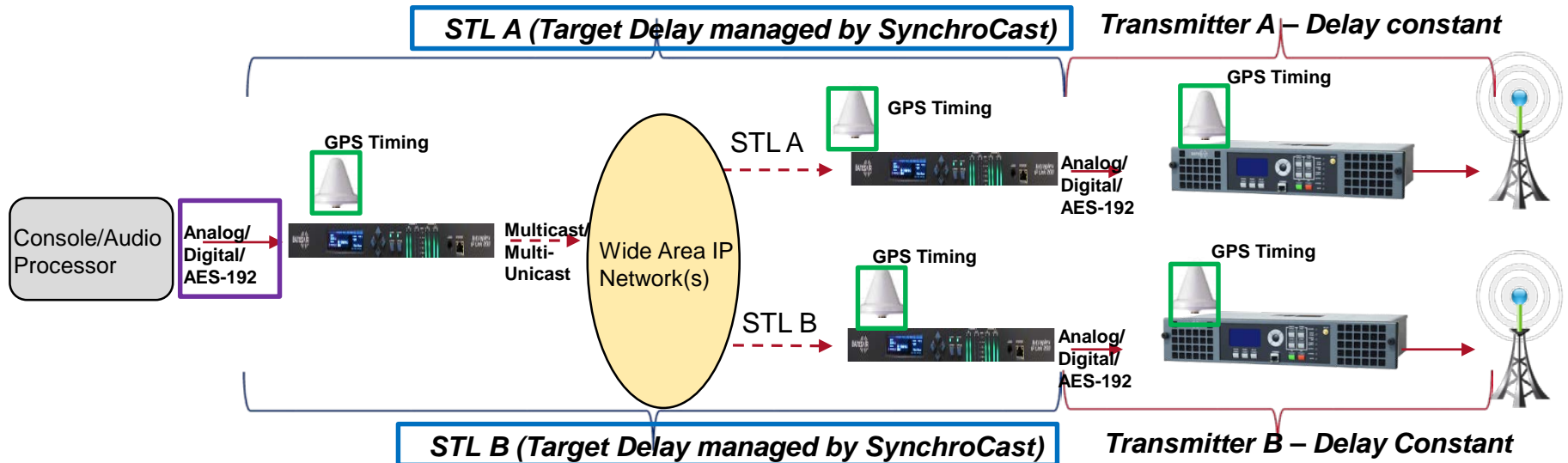

SynchroCast Target Delay Adjustment - Example

Example: Equalize 2 STLs to 100 msec signal delay

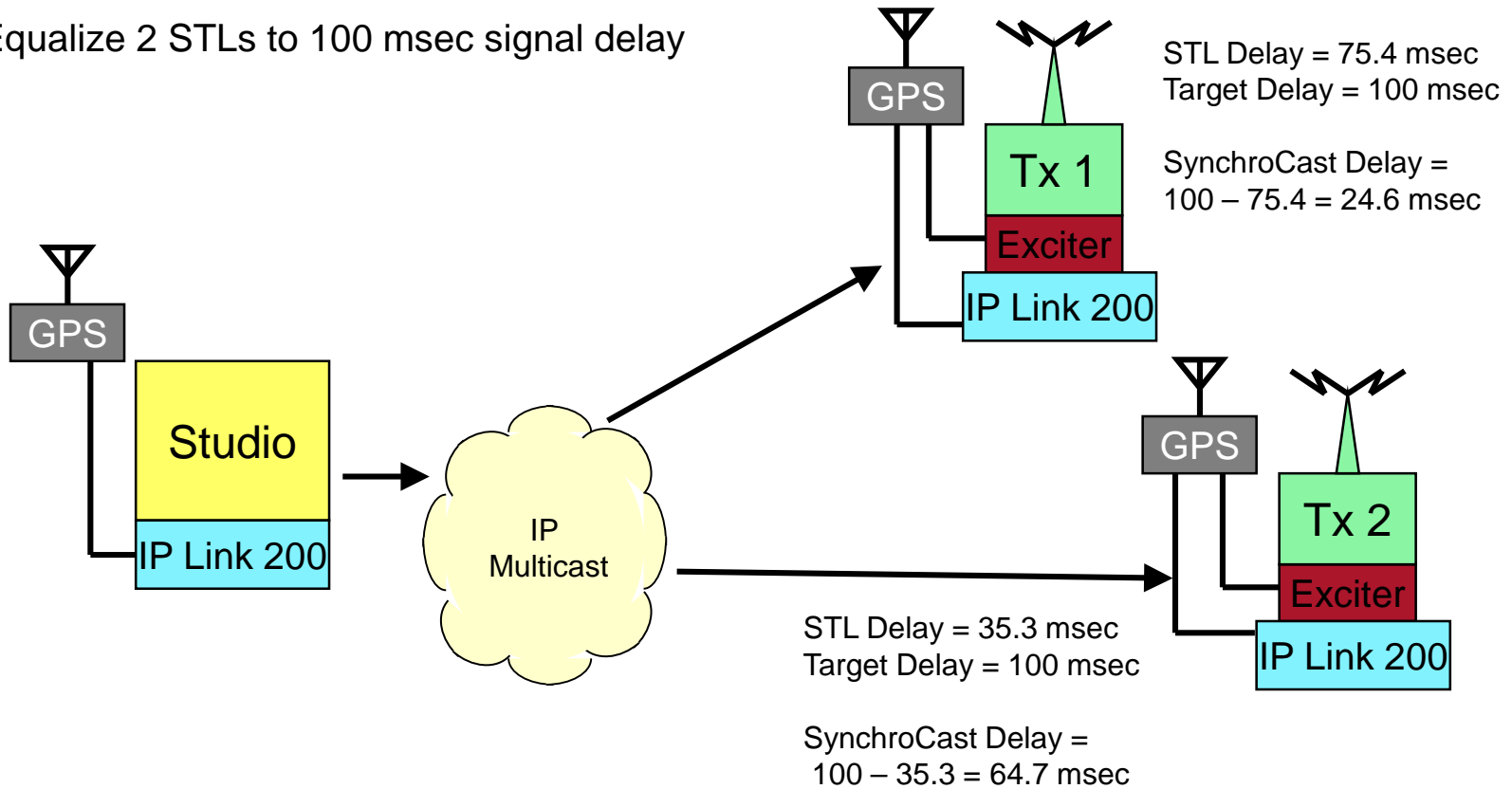

SynchroCast Target Delay

- User sets Target Delay value on each Transmitter site IP Link with 1uSec granularity. Target Delay is the only delay in the chain that can be tweaked
- Target Delay must be greater than sum of IP Link delay + STL network delay
- SynchroCast supports maximum Target Delay of 1 second to allow wide range of IP Network types
- Delay sources within IP Link
 - Audio Packetization + Audio Coding/Decoding
 - Packet loss mitigation techniques (FEC, Stream Splicing)
- Once the Target Delay is set, SynchroCast maintains the delay within 1uSec, which allows for approximately 300 meters of accuracy
- SynchroCast automatically compensates for any changes in the network or IP Link delay



- Overcoming IP network impairments, especially when using ISP networks
 - Variation in network delay
 - Packet losses
- Isolated packet losses will not cause Synchrocast to lose lock on Target Delay
- Packet losses can however degrade audio quality – more severe with compressed audio
- SynchroCast works with IP Link transport reliability techniques
 - RTP/UDP Level FEC – Effective on random packet loss patterns
 - Intraplex Stream Splicing (Time and Network Diversity) – Effective for burst packet losses
 - Stream grouping allows concatenation of techniques
- Use Intraplex LiveLook to analyze the network and select the appropriate reliability option(s)



Reliable Transport – Packet Loss Mitigation

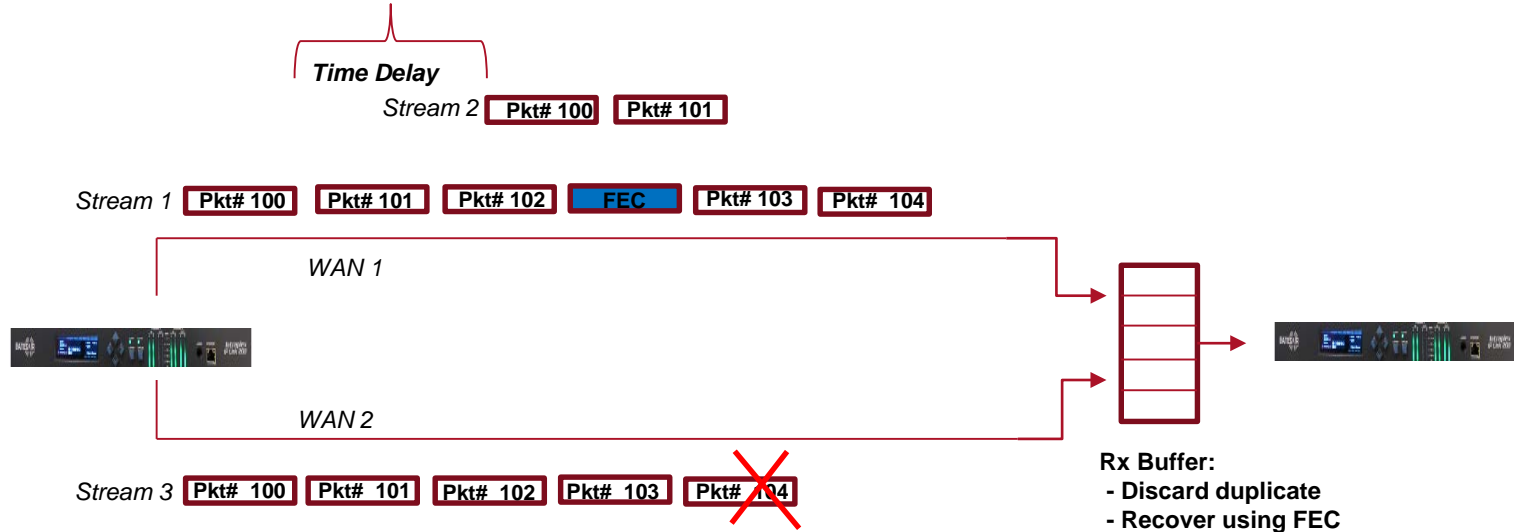

Stream 1: FEC enabled - FEC technique is most effective when packet losses are spread out (i.e following random pattern)

Stream 2: Delayed version of Stream 1 on same network - Time diversity works for burst packet losses on a given network

Stream 3: Same as Stream 1 but using different network – Network diversity provides “hitless” protection and works for burst and random packet loss patterns



Intraplex® LiveLook – Network Analytics



Periodic statistics message

PC Application

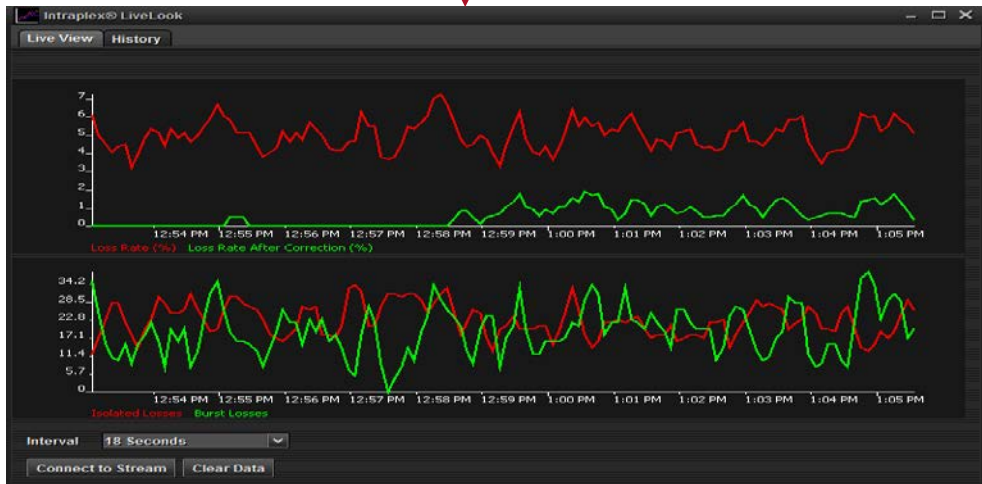

- Network analytics and logging application
- Analyzes packet loss patterns and recommends mitigation option
- Email notification option
- Separate network event logging to help navigate historical data



GatesAir - MaxxCast Outdoor Booster Solution

Outdoor enclosures simplify site construction

19RU Outdoor
Enclosure With
(4000BTU/Hr.) HVAC
unit

- Self-Contained, NEMA 4X Outdoor shelter w/ HVAC
- Reduces site costs
- Fast deployment
- Up to 5kw site complete with cooling, GPS and Synchrocast equipment in small foot print
- Ideal for base of Mobile phone tower or rooftop



IPLink 200
w/ Synchrocast™
Flexiva™
Compact Class
Transmitter

UPS & Power



Case Study – WSUN Clearwater, Florida



WSUN MaxxCasting installation at the Studio STL tower w/Shively Dual 6025 antennas



Connecting What's Next



Case Study – WSUN Clearwater, Florida



Current Coverage

WSUN Channel: 246C2 97.1 MHz
Holiday, Florida
Effective Radiated Power: 11.5 kW
Antenna Center HAAT: 224 m
Omni-Directional Antenna

60 dBu Contour

0.8 kW MAX ERP for MaxxCasting™ Node

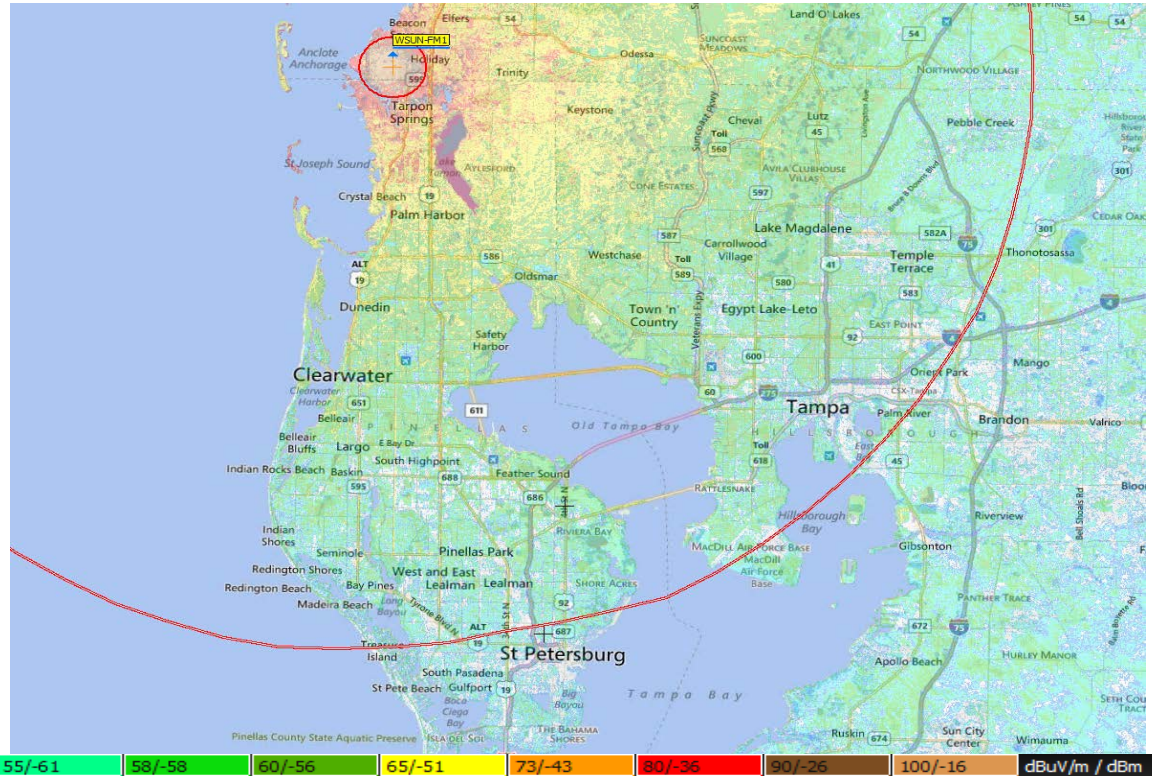

Case Study – WSUN Clearwater, Florida



WSUN
Area of Concern:
St, Petersburg

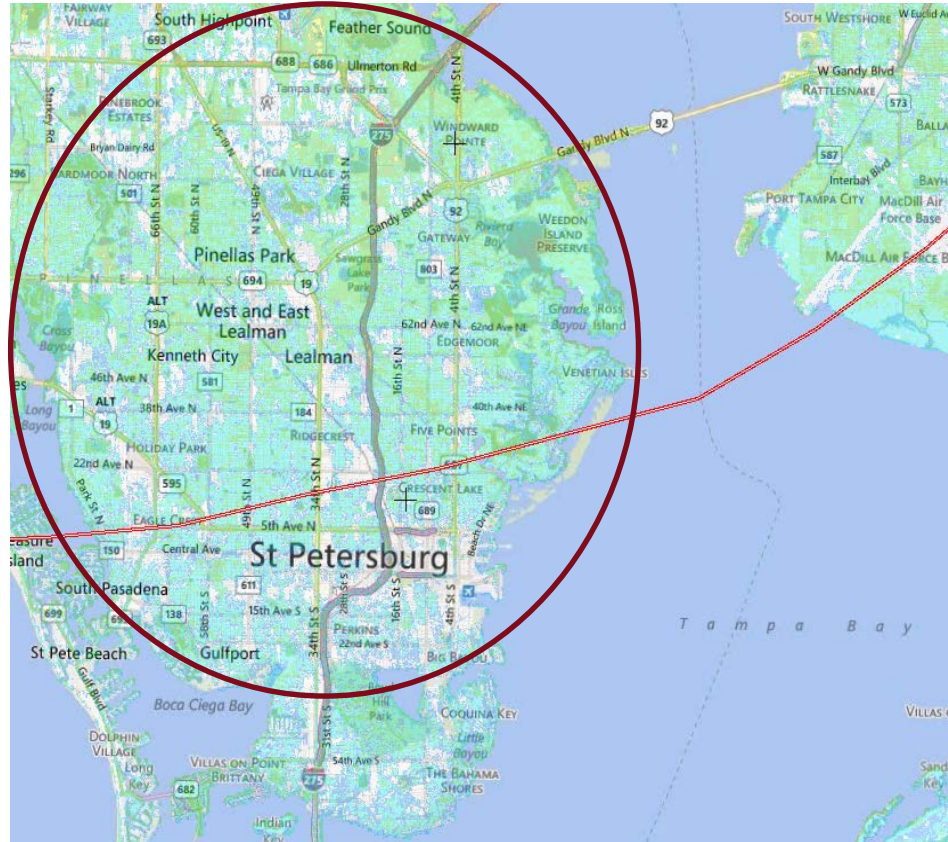

Case Study – WSUN Clearwater, Florida



WSUN-FM Studio Node

Studio Node (stereo)
Dual Log Periodic
ERP: 800W
AGL: 26m

Coverage Numbers
less Interference
Magenta

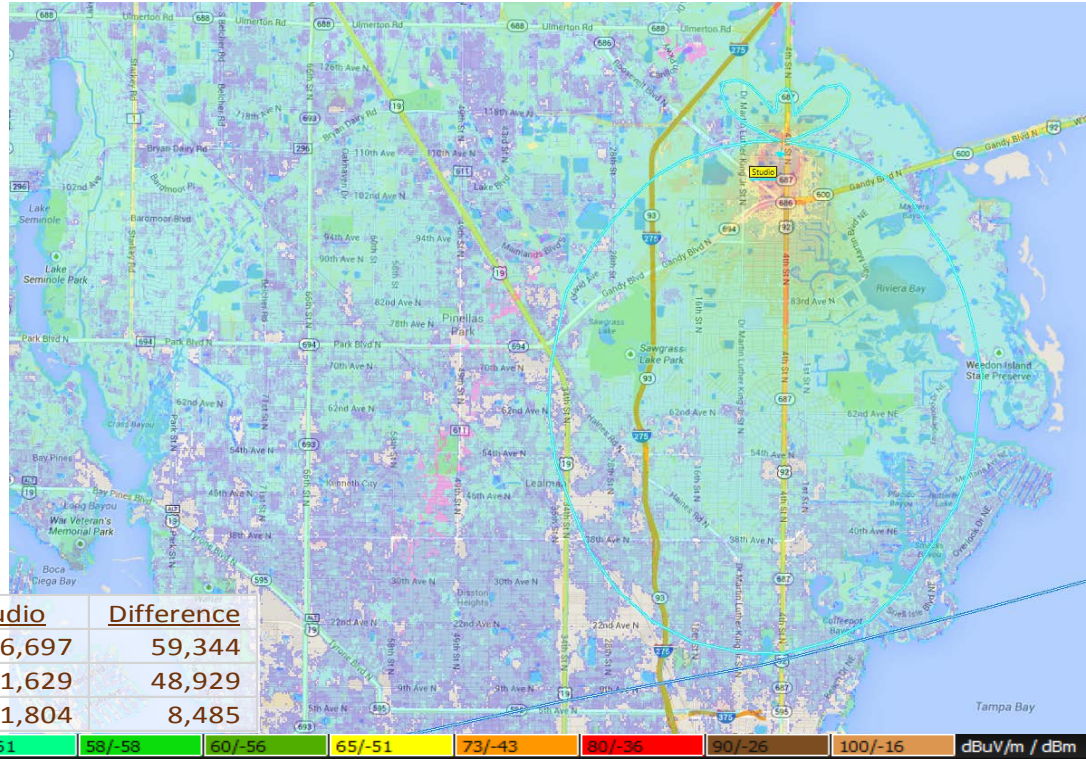

Case Study #2



Case Study – WSUN Clearwater, Florida



WSUN-FM Studio
Three Node Coverage
and Interference

60 dBu Contours

Simulcast Interference
(Magenta)

(Note, 2nd Node and
Translator are proposed)

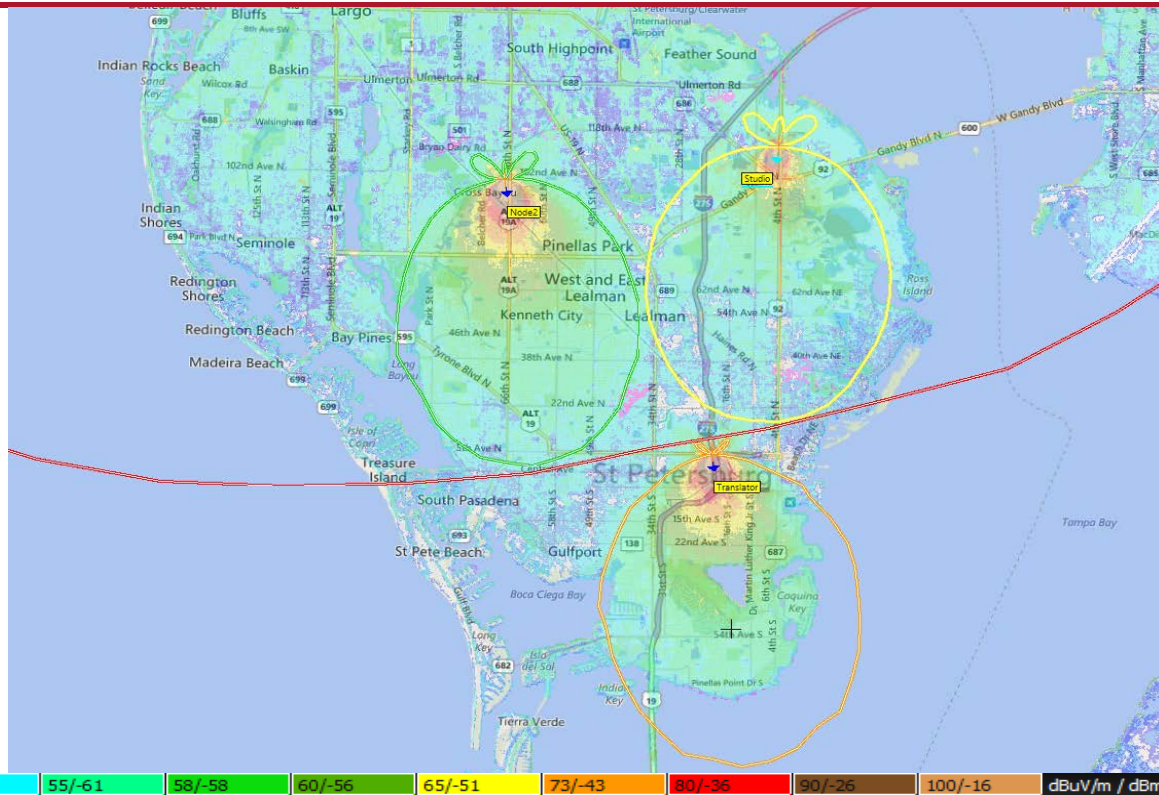

Case Study – WSUN Clearwater, Florida



WSUN-FM Studio
Three Node
Coverage Improvement

60 dBu Contours

(Note, 2nd Node and Translator are proposed)

Simulcast Interference
(Magenta)

Note: Interference where a low quality signal previously existed should not be considered NEW signal degradation

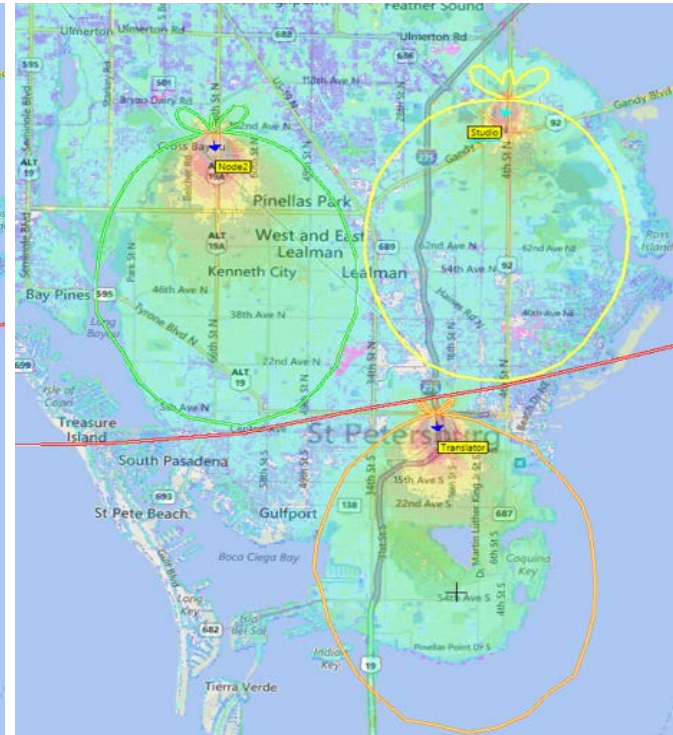
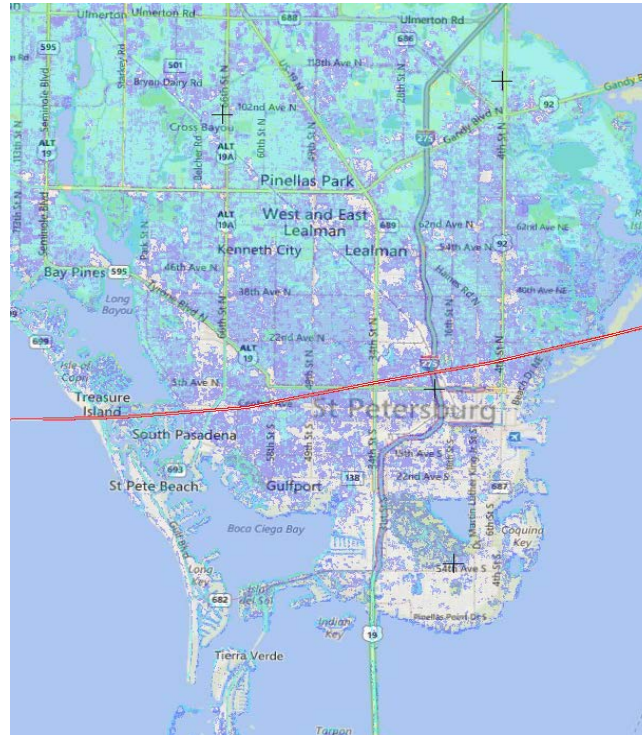

Connecting What's Next



Tim Anderson, CPBE/DRB/CBNE

Radio Product Development and Business Manager

P: (859) 445-7135 | tim.anderson@gatesair.com

www.gatesair.com

Hal Kneller, CBPE

VP Sales & Business Development

P: (941) 391-1958 | hal@geobroadcastsolutions.com

www.geobroadcastsolutions.com

